

14 - DESPIECE / COMPONENTS / ESPLOSO / EXPLOSE / COMPONENTES

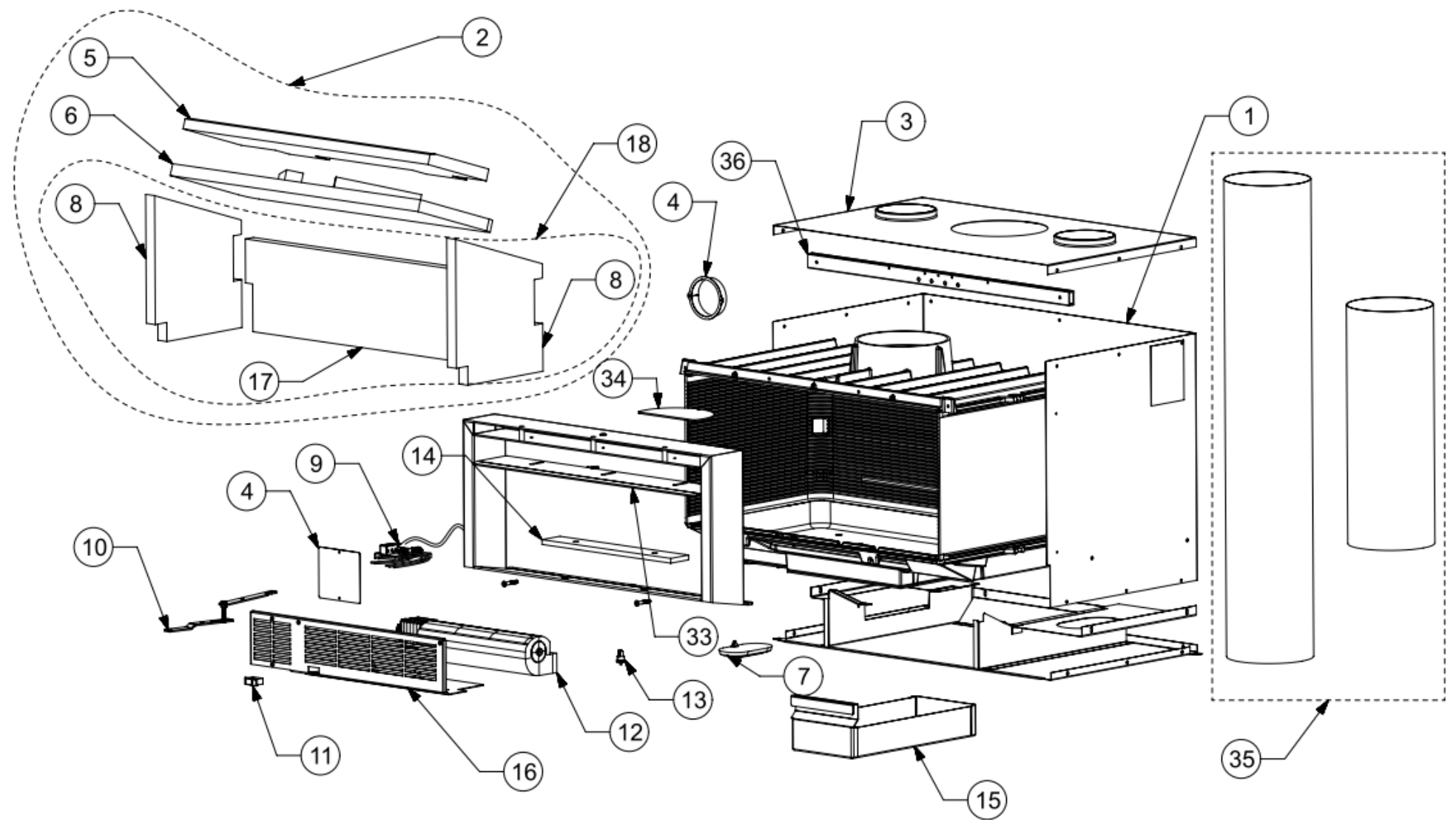

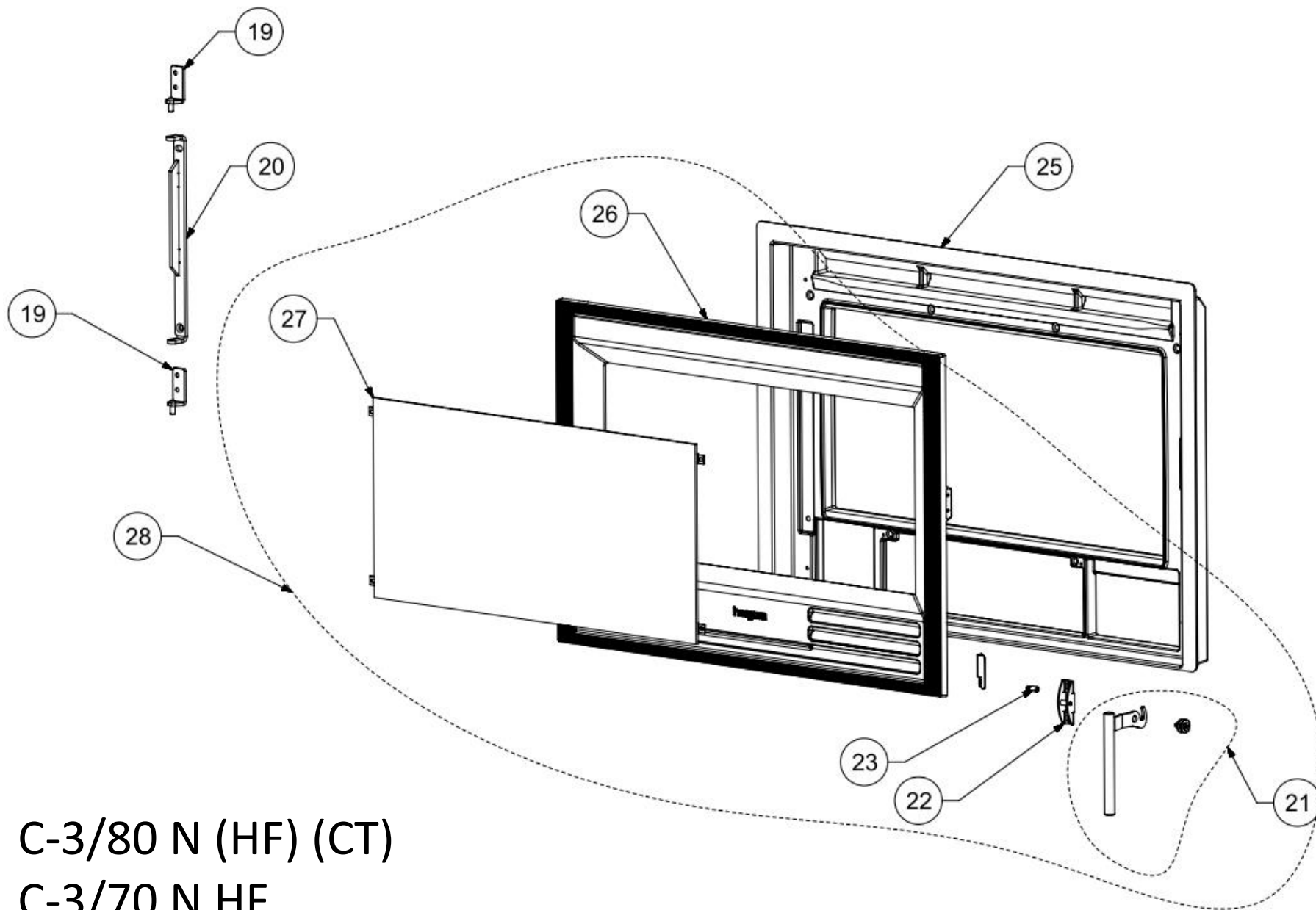

C-3/80 N (HF) (CT)
C-3/70 N HF

N°	CÓDIGO/CODE/CODICE					
	C-16/80 N (HF) (CT)	C-3/80 N (HF) (CT)	NATURE II 80 N (HF) (CT)	C-16/70 N HF	C-3/70 N HF	NATURE II 70 N HF
1	9920878	9920878	9920878	9921094	9921094	9921094
2	9921032	9921032	9921032	---	---	---
3	9920879	9920879	9920879	9921095	9921095	9921095
4	9920880	9920880	9920880	9920880	9920880	9920880
5	9921026	9921026	9921026	---	---	---
6	9921027	9921027	9921027	9921096	9921096	9921096
7	9920323	9920323	9920323	9921097	9921097	9921097
8	9921028*	9921028*	9921028*	9921028*	9921028*	9921028 *
9	9920883	9920883	9920883	9920883	9920883	9920883
10	9921029	9921029	9921029	9921029	9921029	9921029
11	9920138	9920138	9920138	9920138	9920138	9920138
12	9920929	9920929	9920929	9920929	9920929	9920929
13	9920102	9920102	9920102	9920102	9920102	9920102
14	9921030	9921030	9921030	9921030	9921030	9921030
15	9920886	9920886	9920886	9921098	9921098	9921098
16	9920887	9920887	9920887	9921099	9921099	9921099
17	9921031*	9921031*	9921031*	---	---	---
18	9921043*	9921043*	9921043 *	---	---	---

N°	CÓDIGO/CODE/CODICE					
	C-16/80 N (HF) (CT)	C-3/80 N (HF) (CT)	NATURE II 80 N (HF) (CT)	C-16/70 N HF	C-3/70 N HF	NATURE II 70 N HF
19	9920333	9920333	9920333	9920333	9920333	9920333
20	9920331	9920331	9920331	9920331	9920331	9920331
21	9920330	9920330	9920330	9920330	9920330	9920330
22	9920329	9920329	9920329	9920329	9920329	9920329
23	99TE100	99TE100	99TE100	99TE100	99TE100	99TE100
24	9920911	9920911	---	9921110	9921110	---
25	---	---	---	---	---	---
26	9920891	9921040	9920344	9921111	9921112	9920343
27	9920892	9921036	9920341	9921113	9921114	9920340
28	9920991	9921045	9921046	9921115	9921116	9921117
29	---	---	---	---	---	---
30	---	---	---	---	---	---
31	---	---	9901788	---	---	9901778
32	---	---	9920346	---	---	9920346
33	9921038	9921038	9921038	9921103	9921103	9921103
34	9921039	9921039	9921039	9921104	9921104	9921104
35	**	**	**	**	**	**
36	9921105	9921105	9921105	9921106	9921106	9921106

- * no se suministra en la version "HF".
- ** solo version "CT". Suministrado por separado.

- * Not supplied in the "HF" version.
- ** "CT" version only. They are supplied separately.

- * Non fornito nella versione "HF".
- ** Solo versione "CT". Fornito separatamente.

- * Non fourni avec la version « HF ».
- ** Uniquement version « CT ». Fourni séparément.

- * Não é fornecido na versão "HF".
- ** Só na versão "CT". Fornecido em separado.