

ELEMENT **4**

INSTALLATION MANUAL

BIO 501 - BIOETHANOL





DO NOT USE THIS PRODUCT AS A PRIMARY HEAT SOURCE

ALWAYS USE BIOETHANOL OF 85% TO 96,6% ALCOHOL

TABLE OF CONTENTS

1	CE STATEMENT	4
2	IMPORTANT INFORMATION	4
	2.1 SAFETY INFORMATION	4
	2.2 PACKAGING INFORMATION	4
3	WARRANTY	5
4	REMOTE CONTROL AND IGNITION	6
	4.1 REMOTE CONTROL	6
	4.1.1 PAIRING THE REMOTE CONTROL	6
	4.2 FILLING THE TANK	6
	4.4 TURNING THE FIRE PLACE OFF	7
	4.3 IGNITING THE BURNER	7
5	INSTALLATION PREPARATION AND INSTRUCTION	8
	5.1 FLUELESS OR BALANCED FLUE	8
	5.2 INSTALLATION	8
6	SAFETY	9
	6.1 LEAK DETECTION SENSORS	9
	6.2 OVERFLOW DETECTION SENSORS	9
7	BURNER MAINTENANCE	10
	7.2.1 BURNERS	10
	7.2.2 STARTER	10
	7.2.3 THERMOCOUPLE	10
	7.2.4 FUEL PUMP	10
8	DECORATIVE (CERAMIC) PARTS	11
	8.1 DECORATION ARRANGEMENT	11
9	OPERATING THE FIREPLACE	14
	9.1 BEFORE THE FIRST FIRE	14
	9.2 THE FIRST FIRE	14
	9.3 SENSORY CHECKS	14
	9.3.1 VISUAL CHECKS	14
	9.3.2 SMELL CHECK	14
	9.3.3 SOUND CHECK	14
A	TROUBLESHOOTER	15
	A.A FIRST AID FOR MALFUNCTION	15
	A.B NECESSARY TOOLS	16
B	ERROR CODES	17
	B.A MESSAGES SHOWN IN REMOTE CONTROL	17
C	TECHNICAL DATA	19
D	ECODESIGN	20

1 CE STATEMENT

We hereby declare that the design and construction of the Element4 appliances are complying to the essential demands and regulations for gas products.

Product:

Local spaceheater on bioethanol

Models:

Bio 50 i

Applicable harmonized norms:

- BS EN 16647:2015.

This declaration loses its validity when changes to the device are made without the written permission by Element4.



J. Kempers

CEO

2 IMPORTANT INFORMATION

2.1 SAFETY INFORMATION

The fireplace may only be installed by a qualified installer/dealer, following these installation instructions. We advise you to read these instructions properly, before commencing the installation of your device.

Before installation check the device for transport damage and inform your supplier immediately if damage is found.

This device may not be used a primary heat source!

The settings and construction of the device must not be changed!

Parts are only to be changed with original parts by the original manufacturer.

Do not place additional imitation wood or glow material on the burner or in the combustion chamber.

This appliance is designed for use with Bioethanol of up to 96.6%.

Never use bioethanol of 100% purity! It can cause serious damage to the appliance!

This appliance is designed as a heating device and all parts, including the glass therefore become very hot during use (more than 100 degrees). Never touch the appliance during use.

Heat emitted from this appliance may affect nearby materials. Hang curtains at least 50 centimetres away.

Floors, walls and covers (ceilings) must be non-combustible in places where there is a fire risk due to heat radiating from the appliance and/or drainage device.

2.2 PACKAGING INFORMATION

The packaging of the device is recyclable. Packaging can contain:

- Cardboard
- CFC-free foam (soft)
- Wood
- Plastic
- Paper

These materials must be disposed of responsibly and in accordance with government regulations.

Batteries count as chemical waste. Batteries must be disposed of responsibly and in accordance with government regulations. Remove the batteries first before disposing of the remote control.

The government can also provide you with information on the responsible disposal of discarded devices.

3 WARRANTY

NB: Should a problem occur, that you are not able to fix yourself with the help of the support in **APPENDIX A to C**, please contact your installer or dealer.

The Element4 devices on which this warranty is applicable are made of high quality materials. Should any problem or defects still occur the following provision are in effect;

1. Before any installation, the installer will ensure himself of the good quality and operation of the flue channel. The gas fireplaces are to be installed by a competent installer, according to the rules and regulations that are applicable in the country (or even region) of installation and those as described in this manual.
2. There is a warranty period of two years for all Element4 devices, starting from the moment of purchase. The date of purchase should be mentioned clearly on the purchase invoice.
3. The ceramic glass is not included in the warranty, as are the physical or chemical outside influences during transport, storage or montage.
4. If a malfunction should occur during warranty period that is a consequence of an assembly error or material defect, Element4 will provide a free replacement part to the installer, without compensation for disassembly or montage.
5. In case the installer is not able to fix the problem himself, a request can be made to Element4 to do it for him, as long as the service can be done within the borders of the Benelux.
6. Only after consultation up front, the device or loose parts can be sent for check up or replacement. These goods should be sent with the necessary warranty documents and the date of purchase.
7. When a house visit should occur for service purposes by Element4 (within the borders of the Benelux) during warranty period, the right documentation (i.e. this page and a proof of purchase) should be available.

For a house visit for service, outside the warranty period, the following costs are being charged:

- Material costs
- Working hours
- Call-out costs

The warranty is not applicable in the following cases:

1. When one of the previous points is not met
2. When changes are made, of which Element4 is not made aware of / has approved of upfront
3. When device is not installed and/or used properly according to the installation manual.
4. When other than the prescribed decoration material is used.
5. When the device is installed (partially or fully) with other materials than prescribed in this manual.

4 REMOTE CONTROL AND IGNITION

4.1 REMOTE CONTROL

The device is operated by remote image 4.1 control (Figure 4.1) The remote control requires 4 penlite (type AAA) batteries.

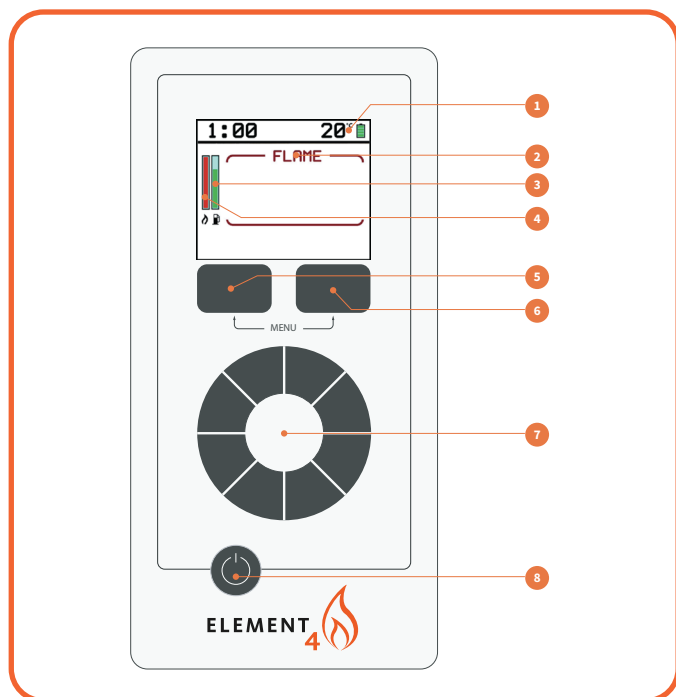


Figure. 4.1 Remote control

1. Room temperature and battery level of remote control
2. Mode
3. Tank level
4. Flame height
5. Left menu button
6. Right menu button
7. Touch dial
8. ON-button

Note that the tank level will show a full green bar up until the fuel level drops under 5%, then it shows a red bar because the tank is almost empty.

4.1.1 PAIRING THE REMOTE CONTROL

To pair an (existing or new) handset with the device, the current paired device must be removed. Do this by selecting DEVICE in the MENU and then holding down the DELETE button. The display now shows NO PAIRED DEVICES.

1. Ensure appliance is switched OFF and isolated from mains power.
2. Touch power button on the remote panel.
3. Select PAIR option on remote.
4. Switch ON appliance by connecting to main 230V.
5. The remote screen will show STANDBY when successful.

4.2 FILLING THE TANK

CAUTION: Use bioethanol of 96.6% - 85% purity.

Under no circumstances should 100% bioethanol be used, this may cause serious damage to the fireplace.

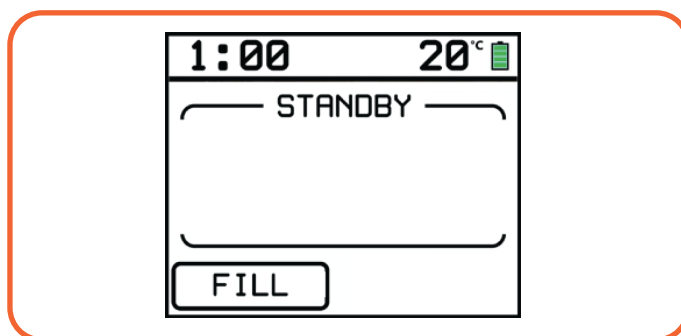


Figure. 4.2 STANDBY mode

Before the fireplace can be lit, the tank must first be filled with bioethanol. Filling can only be done when the stove is in STANDBY mode. See Figure 4.2

CAUTION: If the fire has burned or burned shortly before and has not yet cooled down sufficiently, the tank cannot be filled.



Figure. 4.3 Quick coupling of filling hose extender

1. Make sure that the fireplace is connected to 230V mains voltage.
2. Open the service hatch and take out the filling hose.
3. Connect the filling hose extender to the filling hose by connecting the quick couplings. See Figure 4.3
4. Insert the extended filling hose to the bottom of an opened bottle or jerry can of bioethanol. Make sure that the bottle or jerry can cannot fall over during the filling process.
5. Press the **ON-button** on the remote control to activate it.
6. Press **-FILL-** (left menu button) to start the filling process. The pump is programmed to run for 2 minutes (safety system due to building regulations for filling liquid fuels indoors). However, the pump can be stopped by pressing the **-FILL-** again. It is recommended to stop the pump when using 1L bottles so that the filling hose can be safely inserted into another bottle.
7. The pump stops after 3 minutes or as soon as the tank is full. To check if the tank is full, press **-FILL-** again, a beep will sound and the pump will stop when full.

8. The tank hose can be emptied by pressing the -FILL- button several times while holding the hose upright to prevent spillage. Make sure the hose is completely free of fuel before disconnecting it.
9. The hose can be detached with the quick release button.

4.3 IGNITING THE BURNER

When the tank is filled, the burner can be ignited. Do this by pressing the ON button until the red bar on the display fills and the fire goes into PRIMING mode. See Figure 4.4 and Figure 4.5. This will take about 30 -45 seconds.

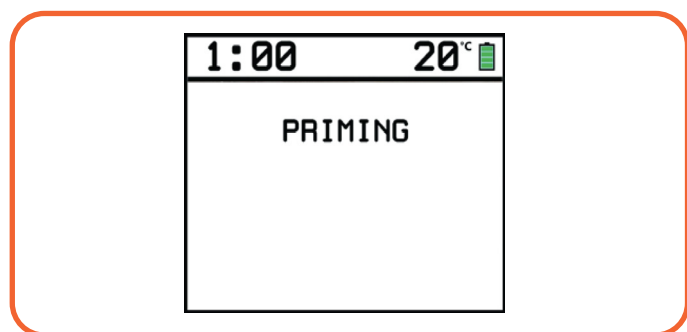


Figure. 4.4 Burner in PRIMING mode

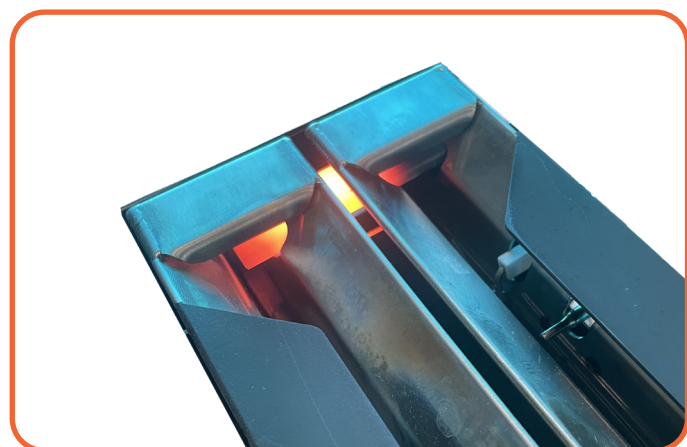


Figure. 4.5 PRIMING: Fuel is going to be ignited

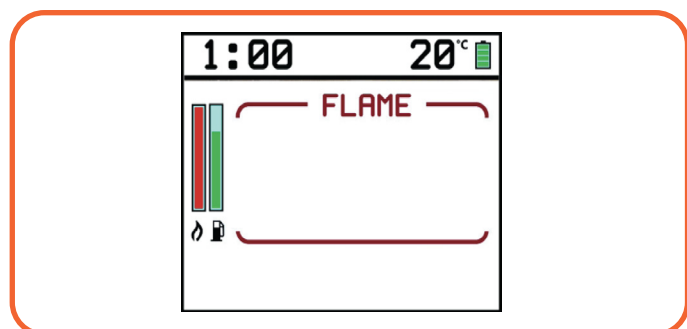


Figure. 4.6 FLAME-mode, burner is turned on

When the fire is burning, a beep will be heard and the fire will go into FLAME mode. See Figure 4.6

To increase the flame height, touch the ON button to activate the remote control and turn the touch dial clockwise.

To decrease the flame height, touch the ON button to activate the remote control and turn the touch dial counterclockwise.

4.4 TURNING THE FIRE PLACE OFF

To turn off the fire, touch the ON button to activate the remote control and then hold the ON button until the red bar is filled. The flames will not extinguish immediately, the fuel present will have to be burned up first.

5 INSTALLATION PREPARATION AND INSTRUCTION

The device has been developed, tested and approved to conform with applicable standards for the usage, performance and safety of the product. The installation of your fire must be made to conform with local building regulation requirements. We strongly advise that an suitably qualified installer is used in the installation of this appliance. The installer can provide you will all the necessary information regarding the safety regulations of the installation

5.1 REQUIREMENTS INSTALLATION LOCATION

This appliance can be installed as a flueless fire. With a flueless installation no flue is required. Extra ventilation into the room may be required to maintain the supply of fresh air – local regulations may apply depending on the country of installation.

It is permitted to place the device in a niche. It is essential that it is constructed from absolutely fireproof material.

Determine the installation location for the device. The appliance must be fixed firmly and level to the floor. Do not make any adjustments to the device.

#	description	
A	Minimal safety margin front	100cm
B	Minimal safety margin sides	100 cm
C	Height installation	0 - 50cm
D	Minimal height niche	75cm
E	Minimal width niche	70cm
F	Minimal depth niche	30cm
G	Minimal safety margin vertical	200cm

Table 5.4 |

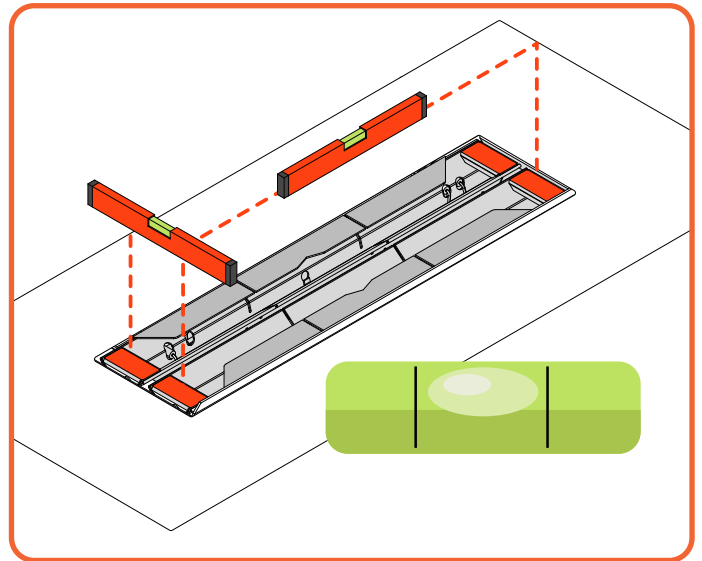


Figure 5.7 | Make sure the burner is level

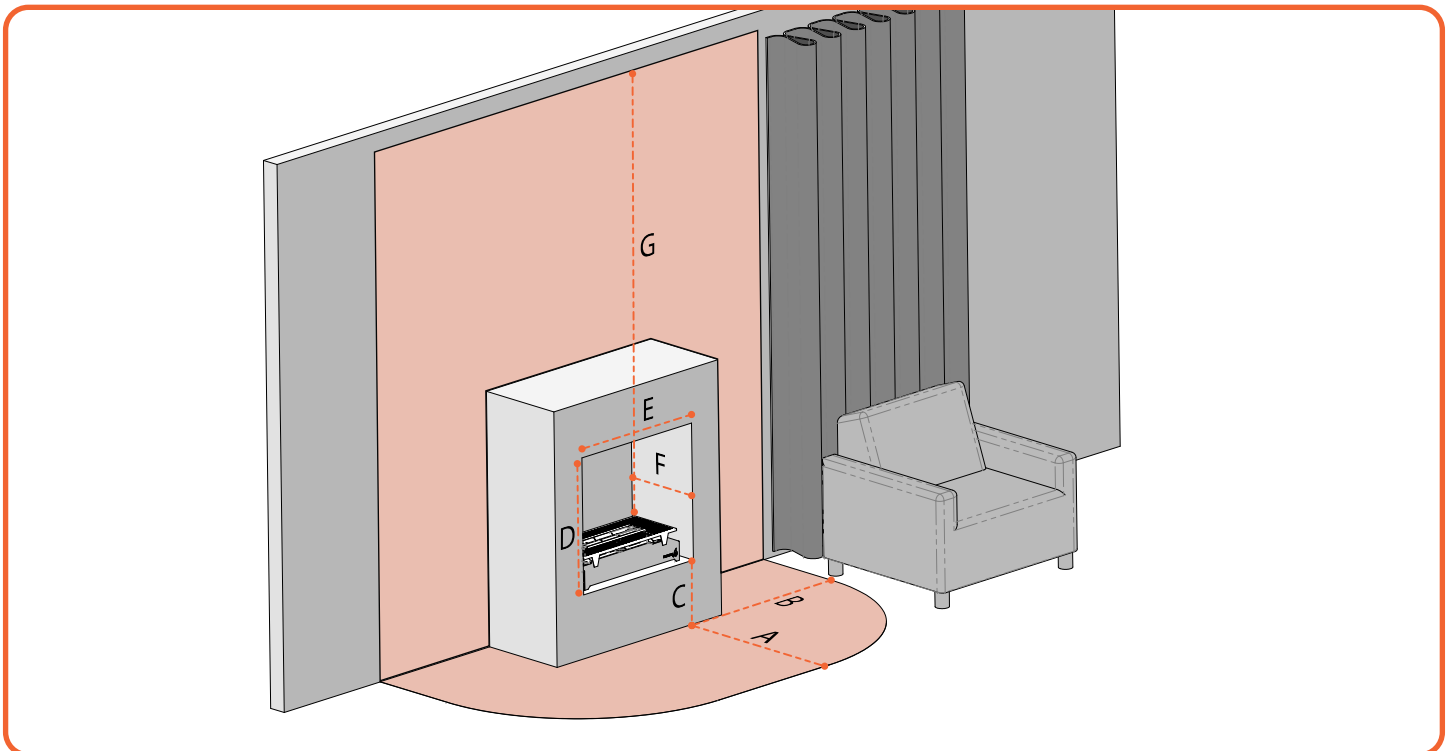


Figure 5.8 | Requirements installation location

6 SAFETY

The Element4 bioethanol fireplace has several safety systems to ensure that it can be used in the safest way. Nevertheless, a few things must be taken into account:

- Never cover your fireplace;
- Keep flammable materials away from flames and sources of ignition;
- Keep children and animals away from the fireplace;
- In case of bioethanol spillage, wipe it up with a dry soft paper or cloth and avoid open flames nearby.
- Please note: the fireplace gets hot during use, so do not touch it for 15 minutes after the flame has completely extinguished.
- Do not fill the fuel tank while the burner is still hot, wait for it to cool down;
- Never pour bioethanol over active fire;
- After extinguishing the flames, wait at least 3 minutes before re-igniting;
- In case of uncontrolled flames, use a fire blanket or extinguisher.
- Do not use water to extinguish the fire;
- After extinguishing the fire, it takes a few minutes for the flames to be completely extinguished;
- In the event that bioethanol is spilled while filling the tank, all parts must be absorbed and dried before an ignition attempt is made;
- The construction elements above the appliance must be made of non-combustible material.
- Do not fill the device before installing it.

6.1 LEAK DETECTION SENSORS

There are leak detection sensors under the burner on the lowest part of the sump and also on the bottom pan below the pumps as shown in [Figure 8.1](#) and [Figure 8.2](#). If there is a leak, the fire will go out by itself. A strong beep sounds through the safety system on the device..

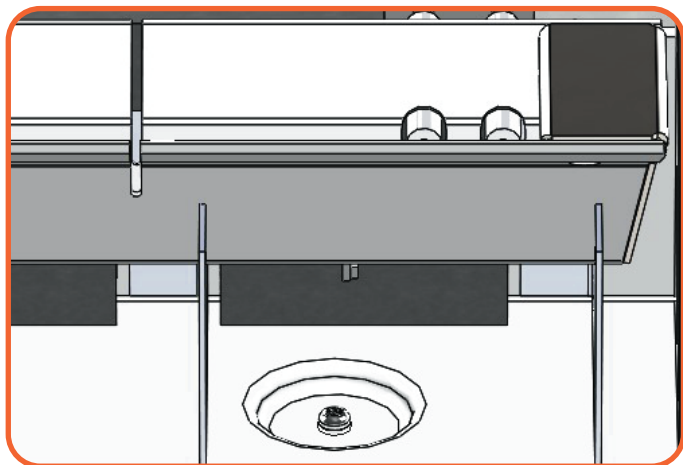


Figure 6.1 | Leak detection sensor underneath burner

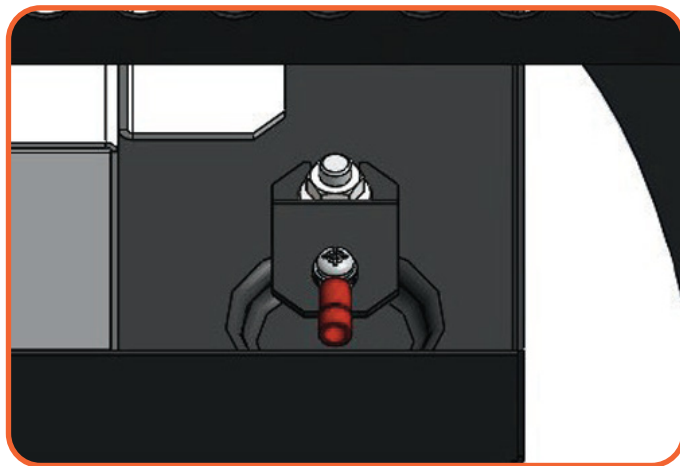


Figure 6.2 | Leak detection sensor on lowest point

6.2 OVERFLOW DETECTION SENSORS

The Bioethanol Fireplace is also equipped with overflow sensors designed to ensure user safety in the event of accidental damage to the pump or electronics. In the event that excess fuel is pumped into the burner, the sensor is activated to turn off the fire. The device will not light up until it is reset again by turning the main power source OFF and ON.

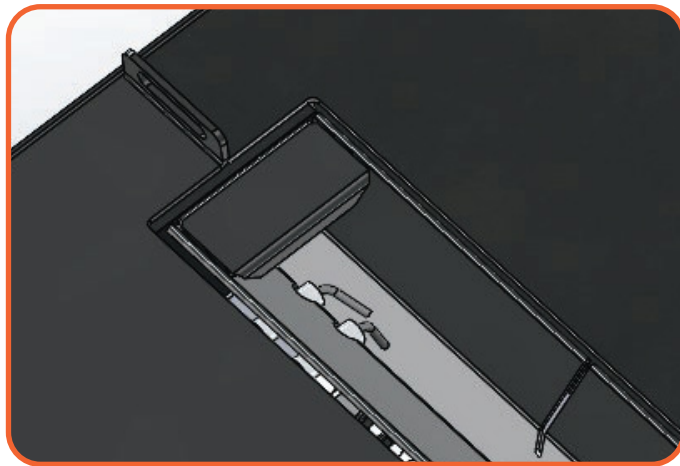


Figure 6.3 | Overflow detection sensor

7 BURNER MAINTENANCE

APPENDIX A has an overview for burner malfunctions. The burner can be reached via the maintenance access.

The starter and thermocouple can be reached through the combustion chamber. Explanation of the starter and thermocouple can be seen in Table 9.1 and Figure 9.9

#	Part
1	Starter
2	Thermocouple
3	Fill pump
4	Fuel pump

Table 7.4 |

7.2.1 BURNERS

The flames of the burners must be checked visually. The flames must be equal in both burner trays. If this is not the case, check whether decorative material has entered the burner..

7.2.2 STARTER

For the proper functioning of the fireplace, the starter must be checked. The starter must start both burner trays and the glowing part must be evenly distributed over the burners. The area around the starter must be kept clean. Decoration materials and dirt can impede ignition. When inspecting the starter, you should also check for damage to the components.

7.2.3 THERMOCOUPLE

The Element4 bioethanol fireplace has a thermocouple that checks whether a fire is burning. It is important that it is clean so that the flame properly heats up the thermocouple. Make sure there is no decorative material between the flame and thermocouple.

7.2.4 FUEL PUMP

The fuel pump pumps bioethanol from the tank to both burner trays. It must be checked whether this is done equally over both gutters. It must also be checked that there is no bio-ethanol leakage in the fuel lines.

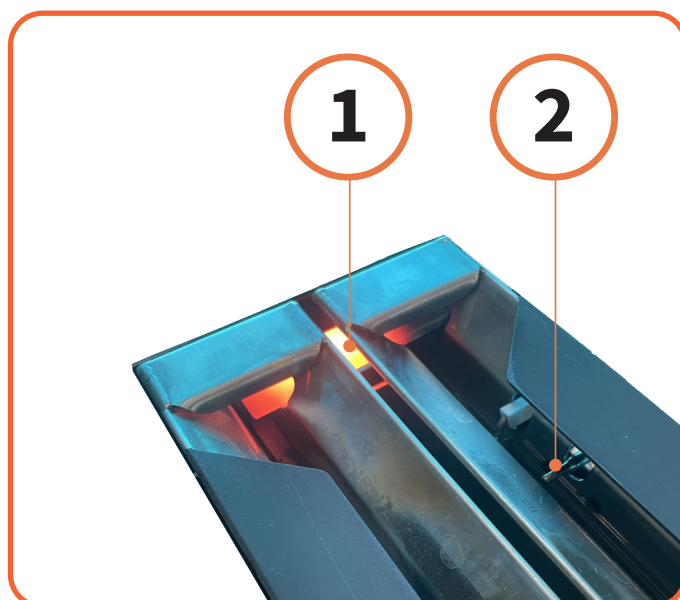


Figure 7.1 | Starter en thermocouple

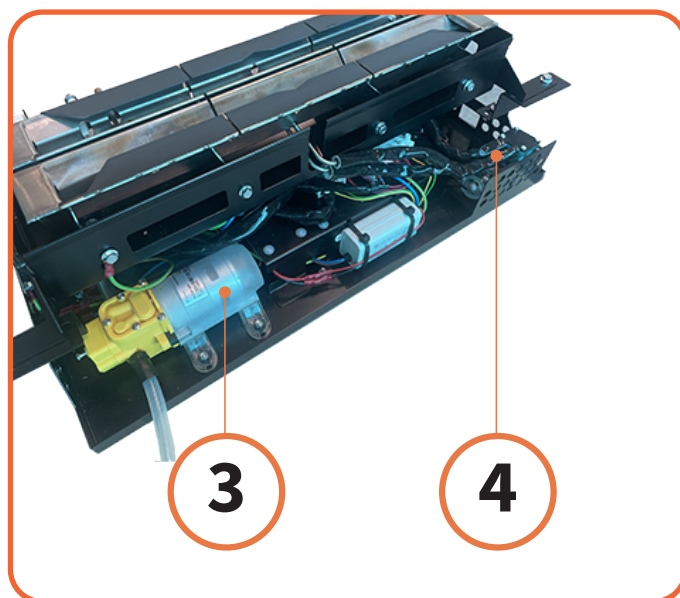


Figure 7.2 | Fillpump en fuel pump

8 DECORATIVE (CERAMIC) PARTS

This appliance is equipped with a ceramic fire bed with heat-resistant ceramic fibers, or artificial glassy silicate fibres. Excessive exposure to this material may cause irritation to the eyes, skin and respiratory tract. We therefore recommend that the dust emission is reduced as much as possible when handling these materials.

8.1 DECORATION ARRANGEMENT

Only the decoration ceramics supplied with this appliance are to be used. The ceramics must be laid only as shown on this page. Replacement parts are available from your dealer, but should only be installed by a qualified installation engineer.

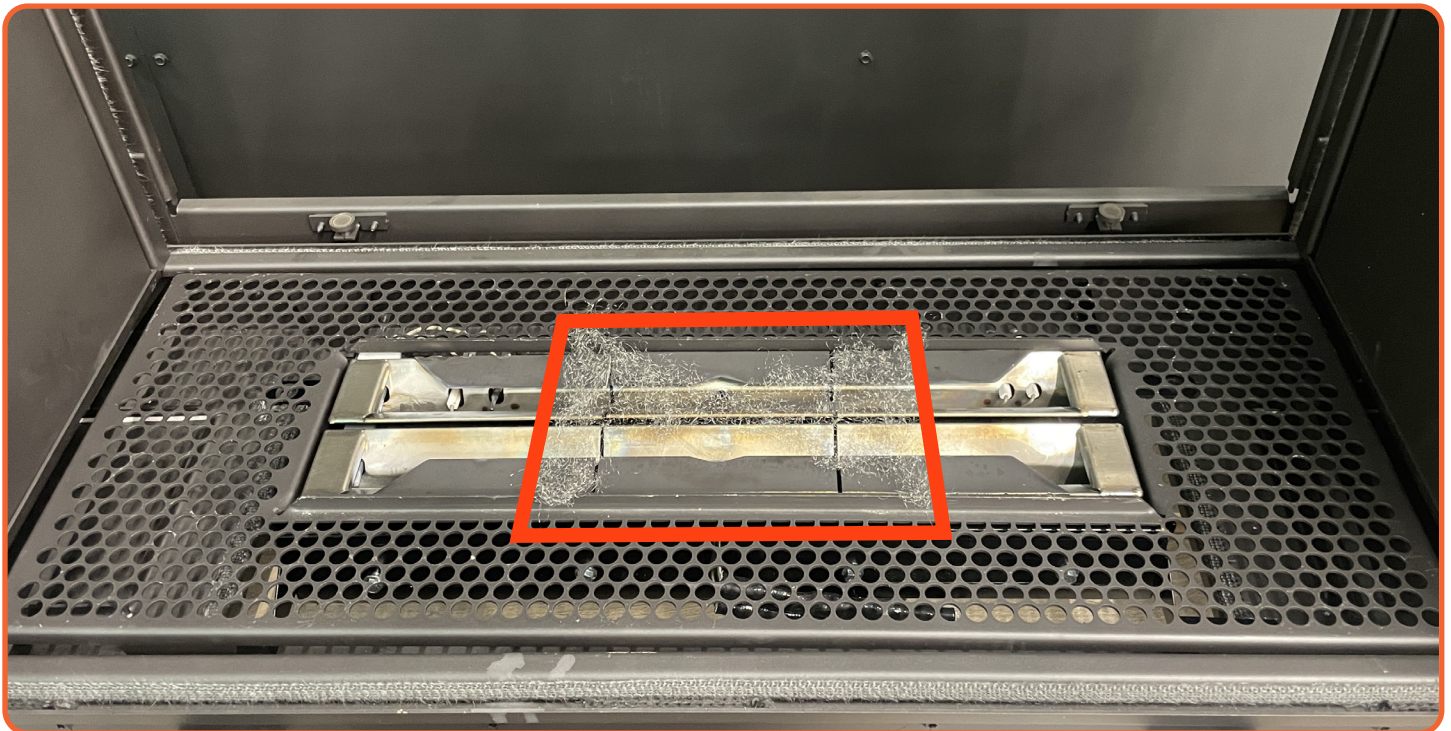
Position the decoration logs as shown on the following steps.

Make sure there is no decoration material directly in the flame when the fire is turned in.

Make sure the burner grate is still open enough to supply the combustion chamber with fresh air.

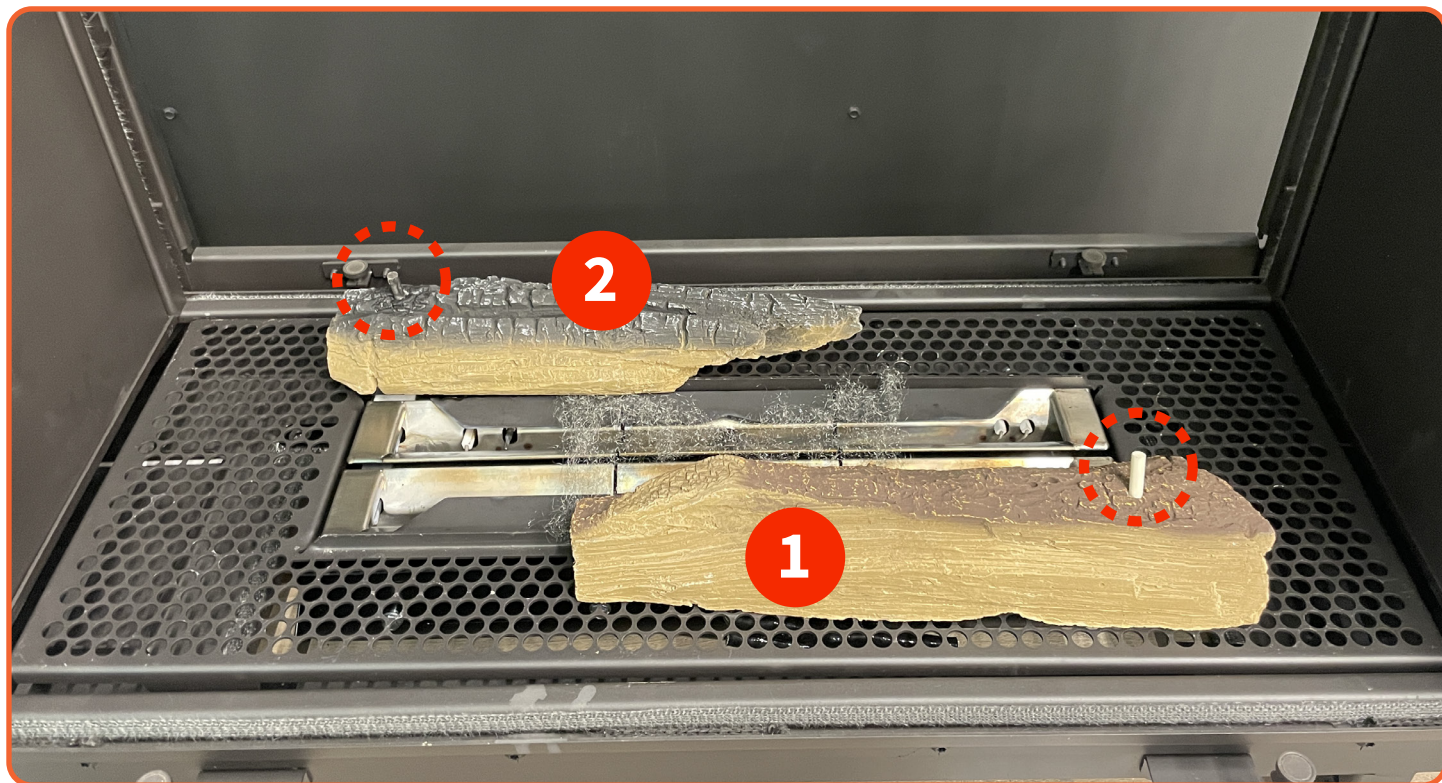


Figure 8.1 | Logset Bioethanol series



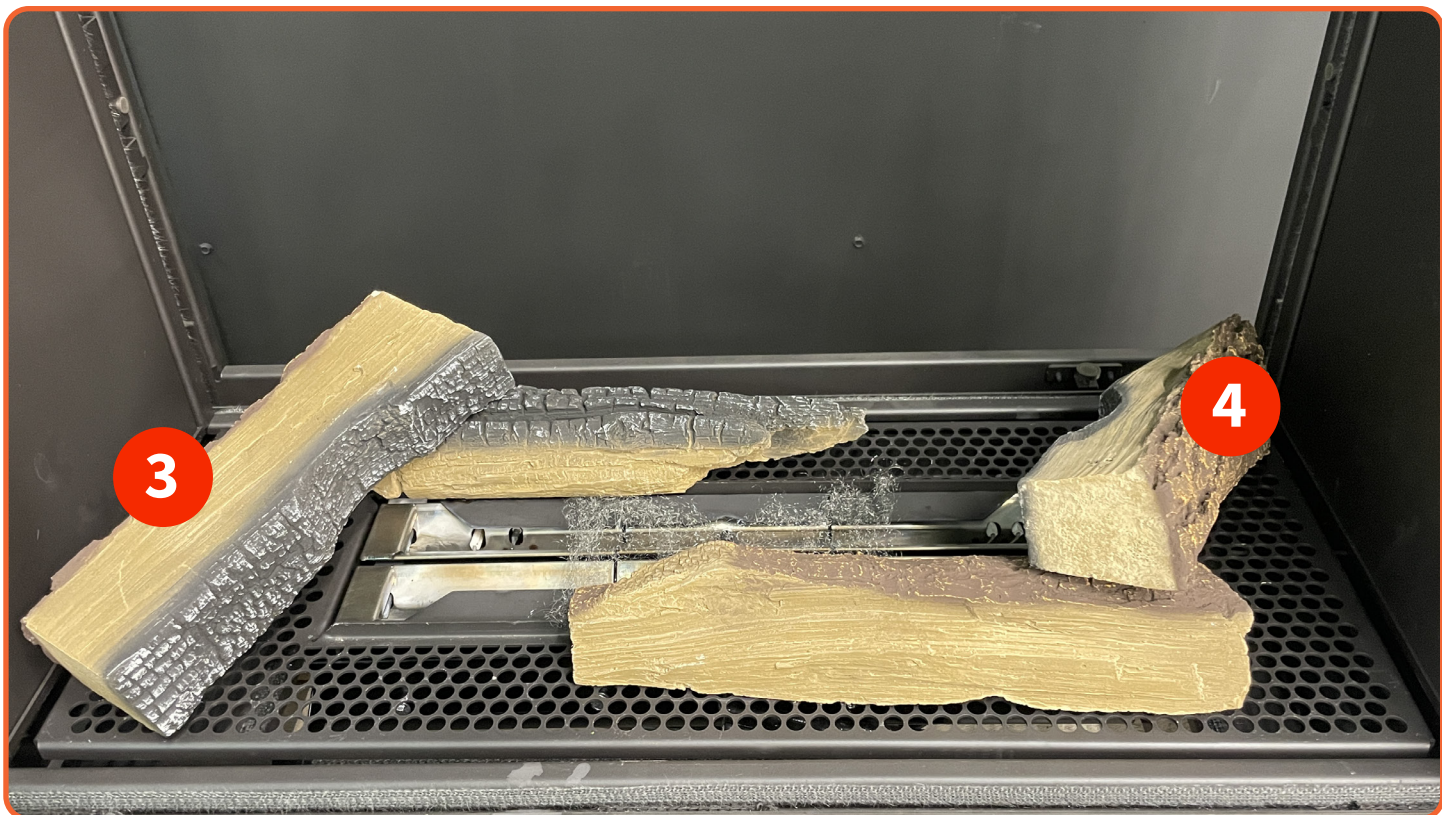
Lay the filament over the burner making sure it is within the orange box remains. The filament must not come into contact with the sensors in the burner.

Figure 8.2 | Step 1



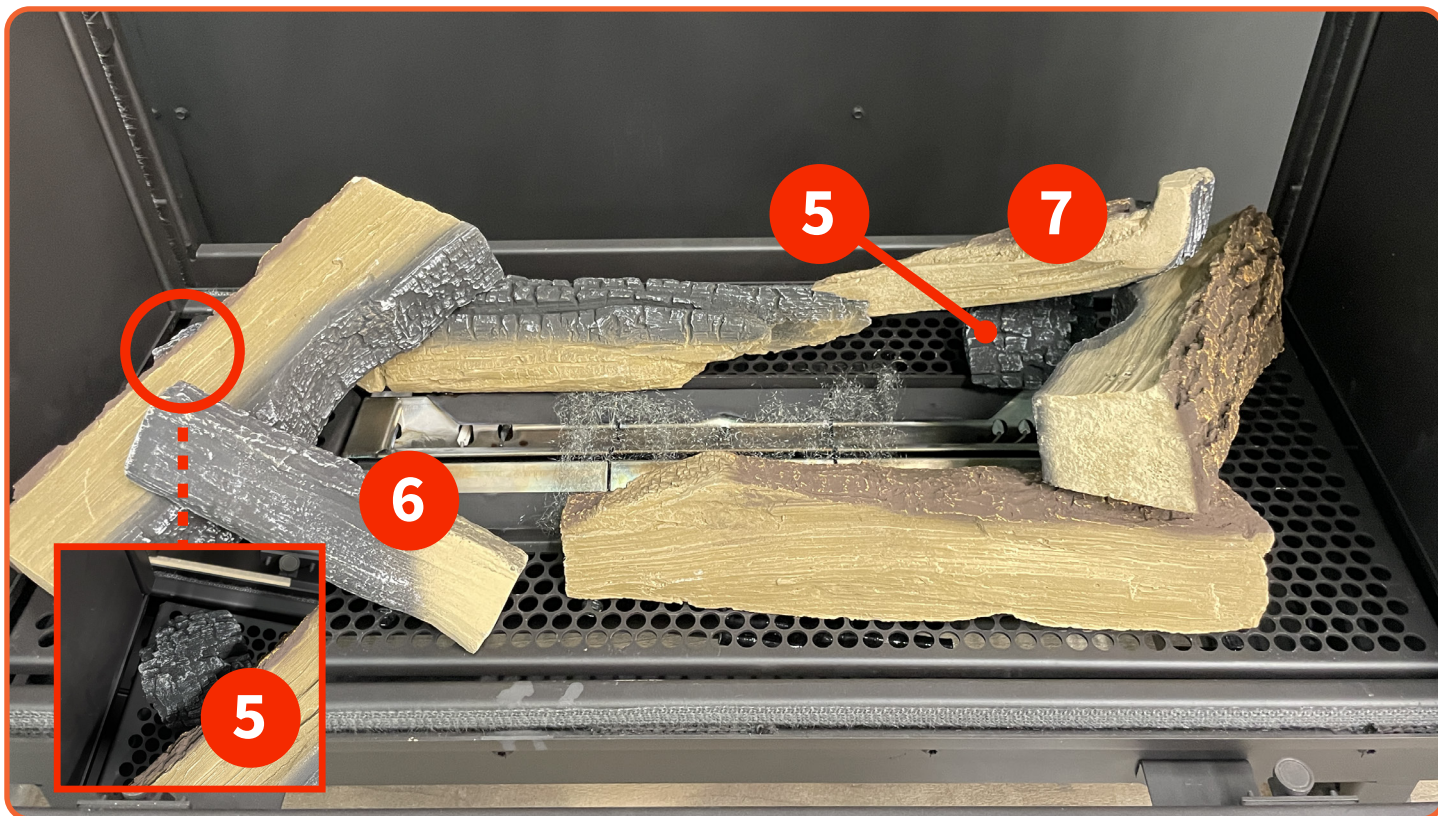
Lay log 1 and 2 with the slit at the bottom over the upright edge. Make sure that the (circled) pins on the logs are on the correct side.

Figure 8.3 | Step 2



Place logs 3 and 4 with the hole at the bottom on the pin of the underlying log.

Figure 8.4 | Step 3



Place the coals (5) in the designated places and then place the logs 6 and 7

Figure 8.5 | Step 4



Fill the rest with black and gray chips. Make sure that the burner grate remains open enough so that air can be sucked in through it.

Figure 8.6 | Step 5

9 OPERATING THE FIREPLACE

9.1 BEFORE THE FIRST FIRE

1. Make certain that all construction materials have been removed from inside and around the fireplace and the fireplace has been cleaned of any construction dust.
2. Clean the glass BEFORE and AFTER the first fire on both sides of the glass.
3. Properly place, clamp and seal the glass panels.
4. Place the four (4) AAA batteries into the remote control and confirm that it will communicate with the receiver by pressing the ON/OFF button.
5. Check the starter and thermocouple for obstructions
6. Check the air tightness of the system.

9.2 THE FIRST FIRE

See **CHAPTER 4** for more information about the remote control and ignition. When the fireplace is fired for the first time, one should check the behaviour of the fireplace to see if all is functioning well.

Should any problems occur during first firing a troubleshooter can be found in **APPENDIX A** for the gas parts and **APPENDIX B** provides an overview of possible error codes in the remote control.

9.3 SENSORY CHECKS

9.3.1 VISUAL CHECKS

Flames and soot

Examine the logs for sooting. Too yellow (near orange) flames indicate a problem with the combustion air. Clear black soot may then settle on the decoration material. When this is the case, you may contact your dealer.

This fireplace has a thermocouple safety system, which senses the burner flame. The system will turn itself off if the system does not sense the thermocouple output.

Coating

When firing up the device for the first time, make sure the device burns for several hours on the highest level, to ensure the lacker to harden. If an enclosure has not yet been constructed, these fumes may also be visible around the fireplace.

Caution: Because a fireplace is a heat source, natural convection will occur around it. Solid particles in the circulating air may burn and settle down on cold surfaces, causing discoloration. Discoloration is an annoying problem and it is difficult to solve once happened.

These particles can come from construction moisture or cigarette smoke, but also they might be volatile components in paint, construction materials or carpeting. For newly constructed chimneys or after a big reconstruction, it is advised to wait a minimum of six weeks before firing a fireplace. After this burn-off period, turn off the fireplace and let it cool completely to room temperature and once again clean both sides of the glass as well as the interior panels.

9.3.2 SMELL CHECK

When the fireplace is first heated, an odour may be given off by the hot metal. Make sure the device and enclosure are ventilated enough, so the possible released fumes are being abducted. The fumes are the result of the 'burn off' of the lubricants and sealants used when manufacturing the fireplace.

We advice to be as little in the room as possible during this process. It is recommended that you open the nearby windows for extra ventilation and then operate the fireplace for at least four hours.

9.3.3 SOUND CHECK

Since the product is a metal fireplace, the heat-up and cool-down cycles may produce some (initial) noises caused by the expansion and contraction of these metals. These are normal but should not be audible at more than a meter distance from the fireplace.

A TROUBLESHOOTER

A.A FIRST AID FOR MALFUNCTION

Below you will find an overview of the possible cause and solution in the event of a failure.

Problem	Possible Cause	Solution
A There is smoke or a strange smell coming from the burner during burning	1 Waste may be burning that is not supposed to be in the burner.	Remove the waste
	2 You are using the wrong fuel (it is essential that you use ONLY prescribed bioethanol).	Check whether you have used the correct bioethanol, if in doubt contact your dealer.
	3 You have placed something around/above the flame that is not approved or recommended.	Remove the object placed in the flame
	4 If the burner is empty (the flame goes out) or you have just turned the fire OFF, this is normal. Like extinguishing candles.	-
B When I try to ignite the burner, it will not start.	5 The quality of the bioethanol you use is not good enough.	Check whether you have used the correct bioethanol, if in doubt contact your dealer.
	1 You have not put enough fuel in the burner.	Fill the tank with bioethanol
	2 You have not used the correct fuel (it is imperative that you ONLY use bioethanol).	Check whether you have used the correct bioethanol, if in doubt contact your dealer.
	3 The air opening of the burner is clogged, there must be sufficient ventilation for the flame to develop.	Check that the flue gas outlet and air supply are not blocked.
C The remote control does not respond to touch	4 The bioethanol is cold and needs time to ignite.	Repeat the starting procedure. In case of structural occurrence, please contact your dealer.
	5 One of the two burners has not ignited, causing the safety system to be activated.	Repeat the starting procedure. In case of structural occurrence, please contact your dealer.
	1 Batteries are empty	Replace the batteries
D When I turn off the fireplace, the fire does not stop immediately	2 Your finger is wet	Dry your finger and try again
	3 You touch the ON button too short.	Try touching the ON button longer.
	1 This is normal, the bioethanol already present must first burn up. The flames will extinguish on their own.	Check plug connections Repair the wiring if necessary
E When I want to fill the tank, the pump does not turn on	1 Tank is already full	-
	2 The fireplace is still in FLAME mode	The fireplace can only be filled in STANDBY mode (See figure 4.6)
	3 The sensor in the tank is defective	Contact your dealer
F When I fill the tank, the pump does not stop automatically when the tank is full	1 You have not used the correct bioethanol	DO NOT START THE FIRE! Use a cloth to clean up the overflowing Bioethanol and contact your dealer.
	2 Sensor is defective	DO NOT START THE FIRE! Use a cloth to clean up the overflowing Bioethanol and contact your dealer.

A.B NECESSARY TOOLS

To help out the installers, mechanics and others who need to do work on our fireplaces e.g. during maintenance, a list is compiled of tools Element4 expects are being carried during said services.

When all these tools are available during service, Element4 guarantees all problems, apart from part failure can be solved.

Please note

If a problem is found, that cannot be solved on site, always contact your dealer or directly contact Element4 via our credentials which can be found on the back page of this manual.



Figure A.A | Tool overview for service

B ERROR CODES

B.A MESSAGES SHOWN IN REMOTE CONTROL

The installed software will give an error/stop code if the bioethanol fire has stopped or not started for any reason. When the bioethanol fire stops, a code is generated, which can be read on the remote control.

By means of the code number you can see in which phase of the ignition process or operation the error occurred.

To view this code, the following steps must be taken:

Open the menu by pressing both buttons below the display.

Select DEVICE

The display shows the version number and stop code as follows:

Display "Rxxx.Dxxx.SCx".

R = receiver software version number.

D = version number of the device software.

SC= stop code in hexadecimal format (as shown opposite).



Figure 9.7 | Foutcode aangegeven op handzender

Foutcode	Omschrijving	Mogelijke redenen	Mogelijke oplossing
SC2	Bioethanol does not reach tank sensor (ignition process)	<ul style="list-style-type: none"> • Too little bioethanol in tank • Sensor defective • Wrong fuel in tank 	<ul style="list-style-type: none"> • Fill tank • Replace or reconnect sensor • Extract wrong fuel from tank
SC3	Thermocouple hot - HOT TRAY (ignition process)	<ul style="list-style-type: none"> • Fire was recently put out 	<ul style="list-style-type: none"> • Wait a few minutes before trying again
SC4	Two minute safety break (ignition process)	<ul style="list-style-type: none"> • The thermocouple has not warmed up sufficiently during the ignition process 	<ul style="list-style-type: none"> • Wait two minutes before trying again
SC5	Low level sensor not reached, pump timed out	<ul style="list-style-type: none"> • Bioethanol is running out and can no longer reach the low level sensor. • Fuel line is clogged or leaking • Pump is defective 	<ul style="list-style-type: none"> • Fill tank • Check for blockages or leaks. If this is the case, please contact your dealer • Check the operation of the pump, contact your dealer if the pump appears to be defective.
SC6	High level sensor not reached, pump timed out	<ul style="list-style-type: none"> • Bioethanol is running out and can no longer reach the high level sensor. • Fuel line is clogged or leaking • Pump is defective 	<ul style="list-style-type: none"> • Fill tank • Check for blockages or leaks. If this is the case, please contact your dealer • Check the operation of the pump, contact your dealer if the pump appears to be defective.
SC7	Timeout, waiting for fuel at low level sensor (ignition process)	<ul style="list-style-type: none"> • Bioethanol is running out and can no longer reach the low level sensor. • Fuel line is clogged or leaking • Pump is defective 	<ul style="list-style-type: none"> • Fill tank • Check for blockages or leaks. If this is the case, please contact your dealer • Check the operation of the pump, contact your dealer if the pump appears to be defective.
SC8	Timeout, waiting for fuel at high level sensor (ignition process)	<ul style="list-style-type: none"> • Bioethanol is running out and can no longer reach the low level sensor. • Fuel line is clogged or leaking • Pump is defective 	<ul style="list-style-type: none"> • Fill tank • Check for blockages or leaks. If this is the case, please contact your dealer • Check the operation of the pump, contact your dealer if the pump appears to be defective.
SC9	Time out, waiting for flame	<ul style="list-style-type: none"> • Thermocouple was insufficiently heated during the ignition process because the flame could not reach the thermocouple. 	<ul style="list-style-type: none"> • Fill tank • Check for blockages or leaks. If this is the case, please contact your dealer • Check the operation of the pump, contact your dealer if the pump appears to be defective.

Foutcode	Omschrijving	Mogelijke redenen	Mogelijke oplossing
SCA	Time out, waiting for high level after flame.	<ul style="list-style-type: none"> The fuel did not reach the high sensor in the burner after the flame lit during the ignition process.. 	<ul style="list-style-type: none"> Fill the tank
SCB	Flame off	<ul style="list-style-type: none"> The flame has gone out for external reasons. Thermocouple is defective 	<ul style="list-style-type: none"> Rule out any possibilities that affect the flame. Try to restart the fireplace. If this does not work, contact your dealer
SCC	Ignition program failed	<ul style="list-style-type: none"> Software problem, the program has become corrupted. 	<ul style="list-style-type: none"> Contact your dealer.
SCD	Stop-command received	<ul style="list-style-type: none"> Normal situation, the user has switched off the fire with the remote control 	<ul style="list-style-type: none"> Restart fireplace with remote control
SCE	Bioethanol does not reach tank level sensor	<ul style="list-style-type: none"> Insufficient fuel in tank to sustain flame. 	<ul style="list-style-type: none"> Fill the tank

C TECHNICAL DATA

The values below depend on the type of Bioethanol used and the way in which the fire is built in.

Note: Always use Bio-Ethanol with 85% to 96.6% alcohol. If in doubt, contact your dealer.

Values for Bio 50i

GROSS output on HIGH* ¹	7	kW
Consumption on HIGH	1,1	L/u
GROSS output on MEDIUM	6,5	kW
Consumption on MEDIUM	1	L/u
GROSS output on LOW	4	kW
Consumption on LOW	0,8	L/u
Minimal room volume	67	m ³
Air renewal rate	1 room vol. per hour	
Rated supply voltage	230	V
Maximum rated power consumption* ²	800	W

D ECODESIGN

Since 1 January 2018 every fireplace has been provided with an ecolabel which is always supplied with the fireplace. The ecolabel shows which category the fireplace belongs to.

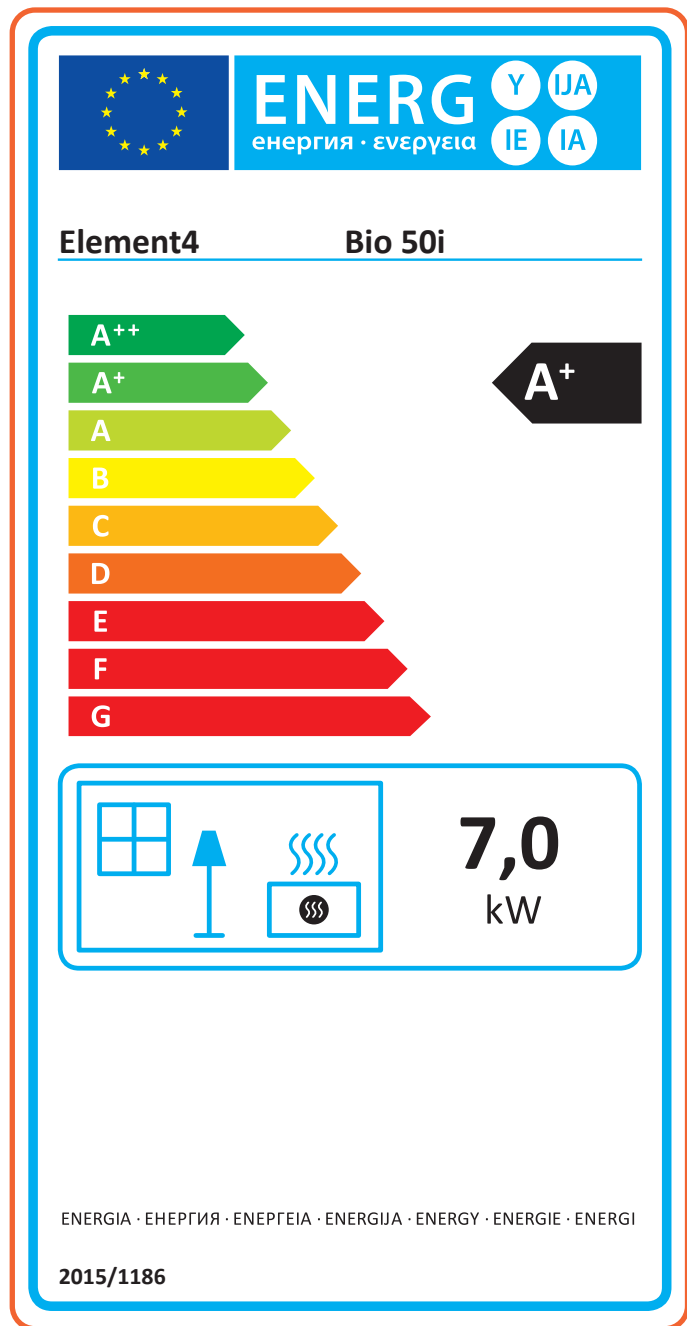


Figure 9.1 | Ecolabel flueless

ELEMENT 4

Design & Assembly by:

ELEMENT 4 B.V.

Info@element4.nl

www.element4.nl

RELEASE DATE | 28/11/23